

WILLY 60 SUSPENSION

D81014-BLK

GENERAL

Series: Willy
 Subseries: Willy 60
 Brand: Panzeri
 Division: Design
 Mounting Type: Suspension
 Mounting Location: Ceiling
 Subcategory: Pendant

PHYSICAL

Shape: Dome
 Diameter (mm): 600
 Diameter (in): 23 5/8
 Height (mm): 370
 Height (in): 14 7/16
 Max. Overall Height (mm): 2370
 Max. Overall Height (in): 93 5/16
 Light Distribution: Direct / Indirect
 Weight (kg): 10.22
 Weight (lbs): 22.53
 Diffuser: Black Blown Glass Dome and Frosted White Glass Bottom Diffuser
 Fixture Material: Glass / Aluminum
 Cable Details: 2000mm (78 3/4") Long Steel Suspension Cables / 2200mm (86 5/8") Long Power Cable In Transparent PVC

ELECTRICAL

Number of Lamps: 3
 Lamp Type: LED Retrofit
 Bulb Included: Bulb Not Included
 Total Output Wattage (W): 45
 Max. Wattage Per Lamp (W): 15
 Lamp Base: E26
 Input Voltage (V): 120

LED

OPTICAL

RATINGS AND CERTIFICATIONS

Certified By: CSA Certified to UL and CSA Standards
 IP rating: IP20

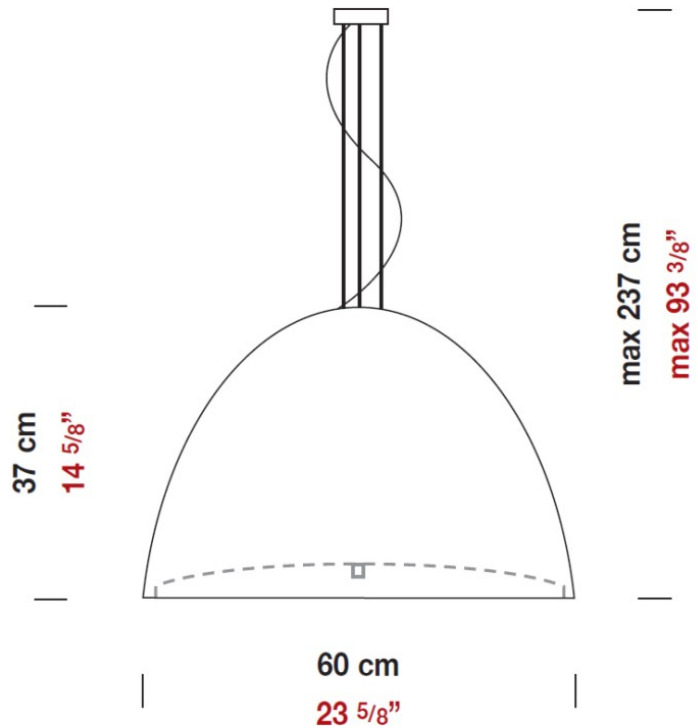

WILLY 40 SUSPENSION

D81057-BLK

GENERAL

Series: Willy

Subseries: Willy 40

Brand: Panzeri

Division: Design

Mounting Type: Suspension

Mounting Location: Ceiling

Subcategory: Pendant

PHYSICAL

Shape: Dome

Diameter (mm): 400

Diameter (in): 15 3/4

Height (mm): 280

Height (in): 11

Max. Overall Height (mm): 2280

Max. Overall Height (in): 89 3/4

Light Distribution: Direct

Weight (kg): 4.09

Weight (lbs): 9.02

Diffuser: Black Blown Glass Dome and Frosted White Glass Bottom

Fixture Finish: BLK

Holder Finish: Metallized Gray

Fixture Material: Blown Glass Lampshade

Cable Details: 2000mm (78 3/4") Long Steel Suspension Cables /
2200mm (86 5/8") Long Power Cable In Transparent PVC

ELECTRICAL

Number of Lamps: 1

Lamp Type: LED Retrofit

Lamp Shape: A19

Bulb Included: Bulb Not Included

Total Output Wattage (W): 15

Max. Wattage Per Lamp (W): 15

Lamp Base: E26

Driver Included: No

Input Voltage (V): 120

LED

OPTICAL

RATINGS AND CERTIFICATIONS

Certified By: CSA Certified to UL and CSA Standards

IP rating: IP20

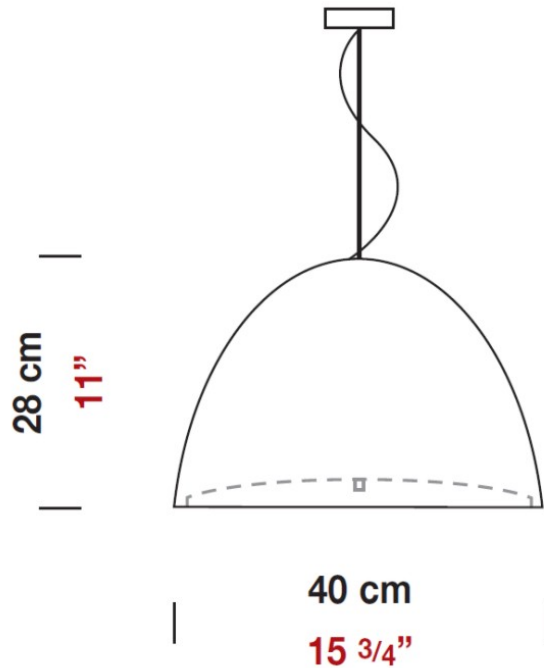

PROJECT	
TYPE	
NOTES	
QUANTITY	
DATE	

WILLY 40 SUSPENSION

D81057-WHI

GENERAL

Series: Willy
 Subseries: Willy 40
 Brand: Panzeri
 Division: Design
 Mounting Type: Suspension
 Mounting Location: Ceiling
 Subcategory: Pendant

PHYSICAL

Shape: Dome
 Diameter (mm): 400
 Diameter (in): 15 3/4
 Height (mm): 280
 Height (in): 11
 Max. Overall Height (mm): 2280
 Max. Overall Height (in): 89 3/4
 Weight (kg): 4.09
 Weight (lbs): 9.02
 Diffuser: White Blown Glass Dome and Frosted White Bottom
 Fixture Finish: WHI
 Holder Finish: Metallized Gray
 Fixture Material: Blown Glass Lampshade

ELECTRICAL

Number of Lamps: 1
 Lamp Type: LED Retrofit
 Bulb Included: Bulb Not Included
 Total Output Wattage (W): 15
 Max. Wattage Per Lamp (W): 15
 Lamp Base: E26
 Driver Included: No
 Input Voltage (V): 120

LED

OPTICAL

RATINGS AND CERTIFICATIONS

Certified By: CSA Certified to UL and CSA Standards
 IP rating: IP20

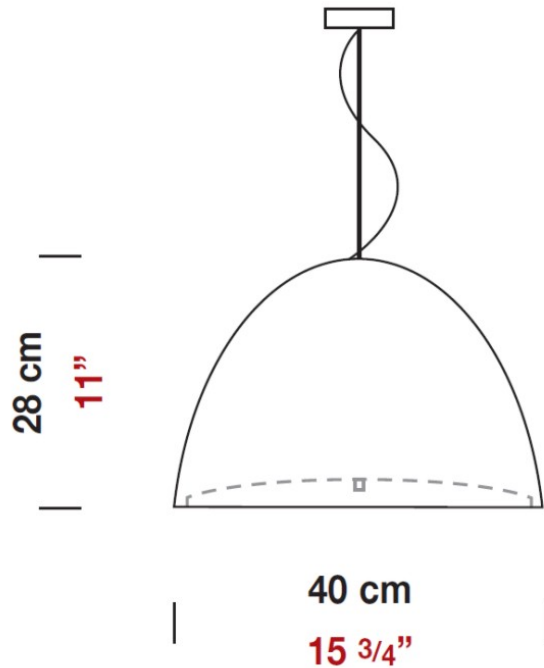

WILLY SUSPENSION

D81060

GENERAL

Series: Willy

Brand: Panzeri

Division: Design

Mounting Type: Suspension

Mounting Location: Ceiling

Subcategory: Pendant

PHYSICAL

Shape: Bell

Diameter (mm): 160

Diameter (in): 6 ¼

Height (mm): 250

Height (in): 9 ⅞

Max. Overall Height (mm): 2250

Max. Overall Height (in): 88 ⅞

Light Distribution: Direct

Weight (kg): 1.23

Weight (lbs): 2.7

Diffuser: Black Blown Glass

Fixture Finish: Metallic Gray

Fixture Material: Metal

ELECTRICAL

Number of Lamps: 1

Lamp Type: LED Retrofit

Lamp Shape: T4

Bulb Included: Bulb Not Included

Total Output Wattage (W): 3

Max. Wattage Per Lamp (W): 3

Lamp Base: G9

Input Voltage (V): 120

LED

OPTICAL

RATINGS AND CERTIFICATIONS

Certified By: CSA Certified to UL and CSA Standards

IP rating: IP20

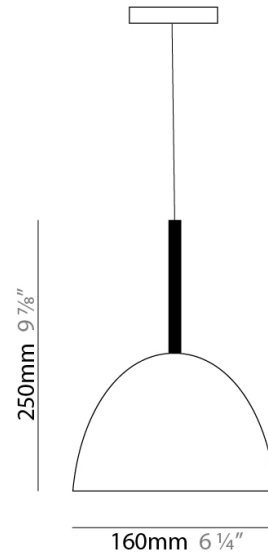

PROJECT	_____
TYPE	_____
NOTES	_____
QUANTITY	_____
DATE	_____

WILLY SUSPENSION

D81344

GENERAL

Series: Willy
Brand: Panzeri
Division: Design
Mounting Type: Suspension
Mounting Location: Ceiling
Subcategory: Pendant

PHYSICAL

Shape: Bell
Diameter (mm): 600
Diameter (in): 23 5/8
Height (mm): 370
Height (in): 14 9/16
Max. Overall Height (mm): 2370
Max. Overall Height (in): 93 5/16
Light Distribution: Direct
Weight (kg): 12.2
Weight (lbs): 27
Diffuser: Metallic Gray Aluminum Dome and Frosted White Glass Bottom Diffuser
Fixture Finish: ALU
Fixture Material: Aluminum

ELECTRICAL

Number of Lamps: 3
Lamp Type: LED Retrofit
Bulb Included: Bulb Not Included
Total Output Wattage (W): 45
Max. Wattage Per Lamp (W): 15
Lamp Base: E26
Input Voltage (V): 120
Upon Request: 277Vac / GU24

LED

OPTICAL

RATINGS AND CERTIFICATIONS

Certified By: CSA Certified to UL and CSA Standards
IP rating: IP20

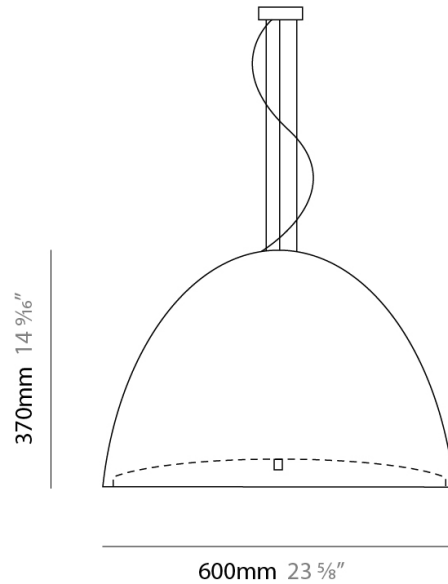

PROJECT	
TYPE	
NOTES	
QUANTITY	
DATE	

WILLY SUSPENSION

D81564-BLK

GENERAL

Series: Willy
 Brand: Panzeri
 Division: Design
 Mounting Type: Suspension
 Mounting Location: Ceiling

PHYSICAL

Diameter (mm): 1000
 Diameter (in): 39 ³/₈
 Height (mm): 630
 Height (in): 24 ¹³/₁₆
 Max. Overall Height (mm): 2630
 Max. Overall Height (in): 103 ⁷/₁₆
 Light Distribution: Direct
 Weight (kg): 15.2
 Weight (lbs): 33.5
 Diffuser: Black Polyethylene Dome and White Frosted Opal Glass Bottom Diffuser
 Fixture Material: Polyethylene Lampshade
 Cable Details: Transparent

ELECTRICAL

Input Wattage Range: 30 - 49 W
 Lamp Type: LED
 Input Wattage (W): 40
 Total Output Wattage (W): 40
 Driver Included: Yes
 Driver Type: Integral LED Driver in Canopy
 Constant Current (MA): 1050

LED

Color Temperature (°K): 3000
 Max. Delivered Lumen (lm): 3859
 CRI: >80 CRI
 Efficiency (%): 78.12

OPTICAL

RATINGS AND CERTIFICATIONS

Certified By: CSA Certified to UL and CSA Standards

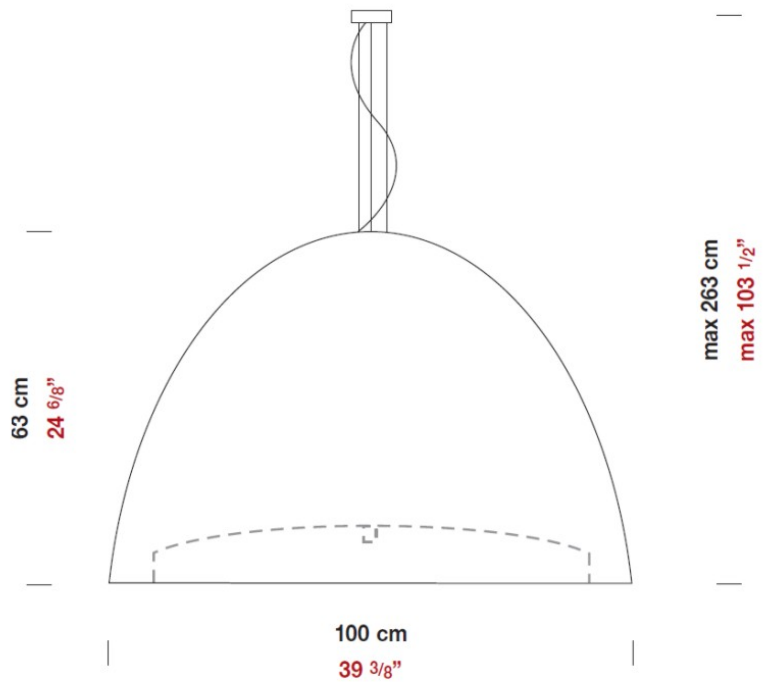

PROJECT	_____
TYPE	_____
NOTES	_____
QUANTITY	_____
DATE	_____

WILLY SURFACE

D83027

GENERAL

Series: Willy
 Brand: Panzeri
 Division: Design
 Mounting Type: Surface
 Mounting Location: Wall
 Subcategory: Uplight

PHYSICAL

Shape: Dome
 Length (mm): 260
 Length (in): 9 7/8
 Height (mm): 210
 Height (in): 8 1/4
 Extension (mm): 130
 Extension (in): 5 1/8
 Light Distribution: Omnidirectional
 Weight (kg): 1.63
 Weight (lbs): 3.6
 Diffuser: Matte White Blown Glass
 Fixture Finish: Metallic Gray
 Fixture Material: Glass / Aluminum

ELECTRICAL

Number of Lamps: 1
 Lamp Type: LED Retrofit
 Lamp Shape: T4
 Bulb Included: Bulb Not Included
 Total Output Wattage (W): 5
 Max. Wattage Per Lamp (W): 5
 Lamp Base: G9
 Input Voltage (V): 120

LED







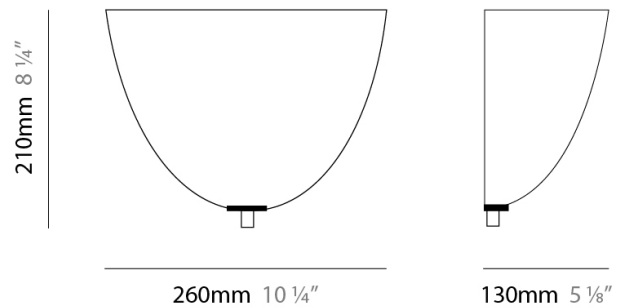





























































OPTICAL

RATINGS AND CERTIFICATIONS

Certified By: CSA Certified to UL and CSA Standards
 IP rating: IP20













LEGEND

	floor-mounted		pivotal		special LED (upon request) RGB, RGBW, tunable, gold+, meat+, art+, fashion+
	wall and ceiling: recessed and surface mounted		rotating		warm dim / natural dimming LED
	ceiling-mounted and wall-mounted		illuminate tilted		rechargeable battery powered
	wall-mounted		color of suspension cable		fixture with natural vivid LED (upon request)
	omni-directional light distribution		length of suspension cable		color rendering index
	direct light distribution		reflector degree selection		color temperature
	direct/indirect light distribution		super spot		lumen (luminous flux)
	indirect light distribution		lens		efficacy (lumens per watt)
	asymmetric light distribution		lens pack		Unified Glare Rating (UGR) range from 5-40
	aura light distribution		shine ring		marine grade (AISI 316 stainless steel)
	round wall or ceiling cut-out		integrated shine ring with diffuser		walk on
	square wall or ceiling cut-out		free individual colors 01-29		drive on
	the supplied jig specifies the cutout dimensions		individual colors: 00 (free of charge), 01-25 (extra charge)		Dark Sky Compliance
	minimum distance (meters) lamp - object		luminaire part to be colored (F1)		Americans with Disabilities Act (less than 4" off the wall located between 27"-84" from floor)
	recessed depth		luminaire part to be colored (F2)		lamp protected against explosion
	ceiling thickness in mm		luminaire part to be colored (F3)		blown glass using traditional methods by master glass blower
	ceiling thickness selection		luminaire part to be colored (F4)		acoustic material
	dimmable DP (phase), DV (0-10V), DD (dali), DS (step-dim)		luminaire part to be colored (F5)		protection class I, protection insulation
	included or excluded LED driver/transformer/control gear		color of 3-circuit adaptor		protection class II, protection insulation
	separately switchable		indirect diffuser		ETL Certified to UL and CSA Standards
	sensor		direct diffuser		UL Certified to UL and CSA Standards
	remote control		ball-proof (upon request)		CSA Certified to UL and CSA Standards
	available upon request		accessory		Certified for North American Standards

IP RATING

	protected against ingress of solid bodies greater than 12.5mm (finger)
	protected against ingress of solid bodies greater than 2.5mm protected against sprays of water up to 60 degrees from the vertical (rain)
	protected against ingress of solid bodies greater than 1mm (wire) no protection against the ingress of moisture
	protected against ingress of solid bodies greater than 1mm (wire) protected against sprays of water up to 60 degrees from the vertical (rain)
	protected against ingress of solid bodies greater than 1mm (wire) protected against water splashed from all directions
	protected against limited ingress of dust (wet rooms/covered outdoor areas) protected against water splashed from all directions
	protected against ingress of dust protected against jets of water
	protected against ingress of dust protected against powerful jets of water or heavy seas
	protected against ingress of dust protected against immersion of water between 15cm - 1m for 30 minutes
	protected against ingress of dust protected against immersion of water under pressure for long periods

IK RATING

	protected against 0.14 joules impact (equivalent to 0.25kg mass dropped from 56mm above the surface)
	protected against 0.2 joules impact (equivalent to 0.25kg mass dropped from 80mm above the surface)
	protected against 0.35 joules impact (equivalent to 0.25kg mass dropped from 140mm above the surface)
	protected against 0.5 joules impact (equivalent to 0.25kg mass dropped from 200mm above the surface)
	protected against 0.7 joules impact (equivalent to 0.25kg mass dropped from 280mm above the surface)
	protected against 1 joules impact (equivalent to 0.25kg mass dropped from 400mm above the surface)
	protected against 2 joules impact (equivalent to 0.5kg mass dropped from 400mm above the surface)
	protected against 5 joules impact (equivalent to 1.7kg mass dropped from 300mm above the surface)
	protected against 10 joules impact (equivalent to 5.0kg mass dropped from 200mm above the surface)
	protected against 20 joules impact (equivalent to 5.0kg mass dropped from 400mm above the surface)